

HUNTING

GUNS





**WELCOME TO
THE TEAM**



PERFECTION IN EVERY DETAIL

Not many family-owned companies can look back on a history of five generations. What our ancestors started in 1886 continues to evolve. Our passion for hunting and technical perfection is what creates and reinforces the bonds between the generations. It continues to this day.

Phil; Cott

Phil Krieghoff
5th generation

CONTENT



6
OUR HISTORY

10
CRAFT



18
OPTIMA



34
HUBERTUS



46
CLASSIC



58
ULTRA 20



70
VICTORIA



72
ESSENCIA



74
TRUMPF

78
SERVICE

TRAVEL THROUGH TIME

Founder Ludwig Krieghoff was already a pioneer in his time. His insight "You shoot with the barrel, you hit with the stock"® is firmly rooted in the traditional manufactory. It forms the basis for the patented Krieghoff custom stock method.



1916

Heinrich Krieghoff, Ludwig Krieghoff's son founds the company "Heinrich Krieghoff", also in Suhl.



1905

Krieghoff's first adjustable insert barrel is patented.

1886

Ludwig Krieghoff, together with a partner, founds the "Sempert & Krieghoff" in Suhl, Thuringia.

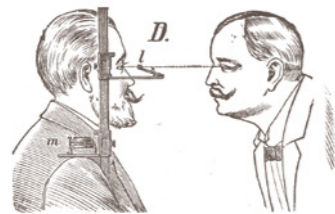

1900

"You shoot with the barrels you hit with the stock"® this finding by Ludwig Krieghoff leads to the patented Krieghoff stock measurement principle.

1906

A pneumatic device to prevent "doubling" on drillings with a single trigger is presented.

❖
"You shoot with the barrels you hit with the stock"®



1926-1930

The first over-and-under combination rifle/shotgun with manual cocking and de-cocking slide is presented. Krieghoff manufactures the world's first lugless shotgun

1925

Krieghoff is the world's first manufacturer to introduce the lightweight Dural as a material in hunting weapon construction.

1932

Krieghoff's semi-automatic rifle with gas-operated loading mechanism and block action debuts.

1919

The companies "Sempert & Krieghoff" and "Heinrich Krieghoff" are merged under Heinrich Krieghoff's direction.

1950

After the end of World War II, Krieghoff starts again in Ulm with 13 employees.

1956

Patent for a safety catch for breech action guns.

1960

The company moves into its present-day production site in Ulm's industrial area.

1957

Krieghoff presents its first competition shotgun: the K-32.

1966

Kenneth A. Jones (USA) becomes Trap World Champion with his Krieghoff K-32.



1967

Patent for free-floating barrels for combination guns.



THIS IS US: TRADITION AND INNOVATION

1992

The Krieghoff combi cocking device and the Universal Trigger System (UAS) are patent-registered.

1996

Adjustable muzzle with integrated wedge patented.

1986

Founding of Krieghoff International Inc. in the USA by Dieter Krieghoff.

1970

Heinz-Ulrich Krieghoff takes over the management of the company.



2002

Optimized Krieghoff Optima Combi-Cocking Device receives utility patent.



2018

The women's edition of the K-20 is introduced at the SCI Convention in the United States, with the name "Victoria".

1968

Patent for a single trigger for multi-barrel guns.

1982

Patented Krieghoff scope mount.

1993

The classic double rifle is presented at the IWA.



1976

Donald Haldeman (USA) wins gold in the Montreal Olympics.



1980

The K-80, successor of the K-32 is introduced. Dieter Krieghoff begins the marketing of Krieghoff shotguns in the USA after his studies.

1995

The light and elegant Single Shot Rifle Krieghoff-Hubertus is being presented.

2000

With the K-20, the "little sister" of the K-80 is introduced.



2009

Phil Krieghoff is appointed Managing Director of H. Krieghoff GmbH.

2016

Contestants using Krieghoff guns win two Olympic medals.

2010

Krieghoff becomes official partner of the 50th ISSF World Championship and since then has had many successes in the Olympic disciplines.



HIGH-TECH MEETS



MANUFACTURING

Modern manufacturing technology does not always produce optimal results. At Krieghoff the most appropriate technology is used in production.



More than half of all Krieghoff employees are hunters or sport shooters; so they know what really matters.

"Custom crafting and fitting by hand ensures a perfect point of impact."



More information on stocks can be found on page 83.

YOU SHOOT WITH THE BARREL – YOU HIT WITH THE STOCK®

The wisdom of Ludwig Krieghoff is just as sound today as it was a hundred years ago. Then as now, a plain piece of wood undergoes a 16-step process during its transformation into a flawless, custom-made stock.



GUNSTOCK MAKER

◆◆ To visualize how best to design the stock from a blank in its raw form, how the composition and grain can be best utilized to maximize strength and beauty, is the essence of the boldness and flair of an experienced stock maker. Before shaping the stock, the wood category must be selected. It takes about eighty years of growth before a stock can be made from the wood of a walnut tree. During this time, nature creates an ever-unique and noble grain that speaks to the senses like almost no other material. Once the final shape has emerged from the chiseling and filing, and the stock has been seamlessly fitted to the receiver, finely carved checkering and surface finishing complete the work of art. Classic oiling or epoxying – both methods uniquely enhance the natural beauty of the wood. The end result is a stock that is a pleasure to hold and behold.

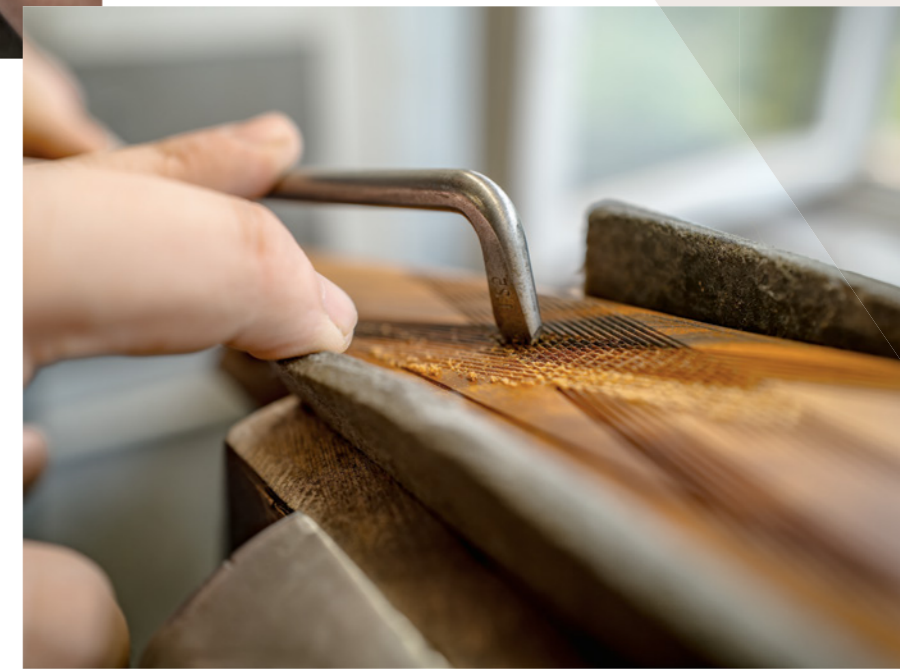

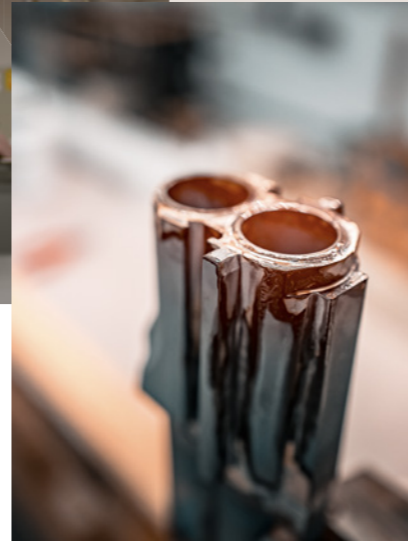

Only the trained eye of the barrel maker ensures a perfect result



More information on barrel options can be found on pages 24–25, 53 and 64–65.



BARREL MAKER

◆◆ Still, a Krieghoff's life does not begin until each of its parts has been assembled into a perfect whole by the hands of a knowledgeable gunsmith. Modern production technologies are indispensable in today's gun making, however, all crucial phases during the manufacturing of a gun are still done by the hands of an experienced gunsmith. Every craftsman completes his task with a passion for making every detail perfect. This is our commitment and goal to ensure the best quality possible.



More information on engraving and finishing options can be found on page 82.



The engraving expresses the owner's personality and individuality

ENGRAVER

◆◆ For years, engravers have artfully applied the finishing touch to guns, lending them a unique character and an expression of their worth. A dialogue with the customer results in initial sketches, which are used to produce a harmonious design encompassing motif, style, and material. Krieghoff engravers have a comprehensive repertoire: from deep relief to the very finest Bulino style and from classic hunting scenes to the multifaceted ornamentations of various eras. From precious metal inlays to surface finishing – there are no limits to their creative imagination. Using their experience, finesse, and talent, our engravers create fine works of art that reflect both the passion and personality of the owner and the value and quality of an exquisite gun.



Further examples can also be found at www.krieghoff.de/engraving



Engraving galleries can be found on pages 32–33, 44–45, 56–57, 68–69 and 76–77.



OPTIMA



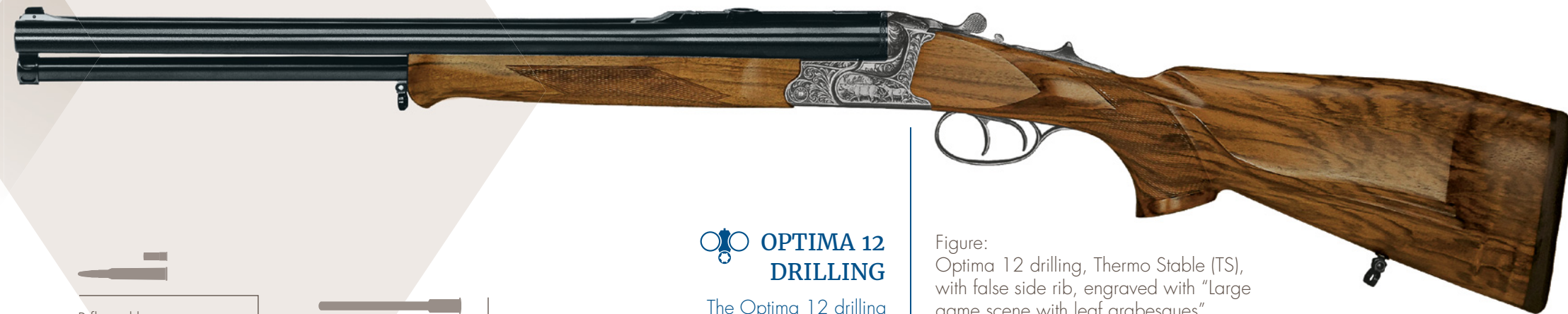

OPTIMA 12 DRILLING

The Optima 12 drilling system can be modified to create a double rifle drilling with insert barrels.

Figure: Optima 12 drilling, Thermo Stable (TS), with false side rib, engraved with "Large game scene with leaf arabesques", wood category 3

Rifle calibers ranging from 6.5 mm to 9.3 mm can be selected.

Up to .500 N.E. for Optima "Big Five"

Available gauges: 12/76 or 20/76

A large selection of insert barrels is available.



Available in barrel lengths of 55 cm (21.5") and 60 cm (23.5") soldered or Thermo Stable (TS), available as regular drilling or double rifle drilling.

Barrel configurations and insert barrels can be found on page 24.



Designed for easy installation of a Bridge Pivot Mount. Includes manually folding rear sight as standard feature.



Receiver size 12 or 20/
Receiver material; steel for 12 gauge, steel for 20 gauge
Optional side plates

Choose your standard engraving, or have our engravers use your own design.

Inspiration for custom engravings can be found on pages 32-33.



Burled walnut wood available in eight progressive grades

Special forms as hand-crafted custom stocks

OPTIMA THE DRILLING FOR THE 21ST CENTURY

OPTIMA 20 DRILLING

The Optima 20 drilling system allows the use of genuine double rifle drilling barrels and Optima Big Five barrels.

Figure: Optima 20 drilling, Thermo Stable (TS), with false side rib, side plates, engraved with "Large game scene with oak leave", wood category 4

- Twin-hammer drilling with the exceptionally smooth Combi-Cocking device and Universal trigger system (UAS).
- Different variants are available (double trigger, single trigger, one-two trigger).
- Receiver made of steel
- Steel shot proofing optional
- Choice of "TS" barrel or soldered barrel
- Insert barrels in big game calibers possible
- Double-rifle drilling also available in big game calibers

OPTIMA STANDARD FEATURES

- Hair trigger in front trigger
- Universal trigger system
- Combi-Cocking device
- Steel trigger guard
- Ready to accept bridge pivot mount
- Suitable for loading steel shot depending on choke and receiver material
- Removable sling swivels
- Steel trigger plate (with steel receiver)
- Nickel-plated receiver
- Border engraving
- Blued hinge pin, top lever, cocking slide and trigger guard
- standard wood grade
- Right-handed stock with Bavarian cheekpiece
- Schnabel-style forearm
- Supplied in a Krieghoff GunPack



OPTIMA BARREL TYPES AND INSERT BARREL

Drilling barrel sets available with a length of 55 cm (21.5") or 60 cm (23.5"). Optional soldered or thermally stable. Available shotgun caliber: 12/76, 20/76
Rifle caliber: 6,5x57R, 6,5x65R, 7x57R, 7x65R, .308 Win., .30-06, .30R Blaser, 8x57IRS, 8x75RS, 9,3x74R

Double rifle drilling available with a length of 55 cm (21.5"), soldered, with muzzle adjustment. Available shotgun caliber: 20/76
Rifle caliber: 7x57R, 7x65R, .308 Win., .30-06, .30R Blaser, 8x57IRS, 8x75RS, 9,3x74R

"Big Five" double rifle drilling calibers:
.375 H&H Mag.,
.450/.400 N.E.,
.500/.416 N.E. (3¼"),
.470 N.E.

The Optima 20 drilling can be converted in a few easy steps into a genuine double rifle drilling or Big Five double rifle drilling by using interchangeable barrel sets, which can be retrofitted at any point in time.

Insert barrels can be removed and re-inserted with perfect fitting by our gunsmiths at the hunter's request without changing the point of impact.

1. Barrels: Thermo Stable drilling barrel set with 12 gauge shotgun barrel and free-floating rifle barrel.

2. Thermo Stable barrel set with 12 gauge shotgun barrel and free-floating rifle barrel plus insert barrel in caliber suitable for deer in the left shotgun barrel.

3. Soldered barrel sets, with 12 gauge shotgun barrels.

OPTIMA

20

OPTIMA

12

4. Double rifle drilling, soldered with muzzle adjustment.

5. "Big Five" double rifle barrel set completely soldered.

Perfect for driven hunts. A "genuine" double rifle drilling: sleek, responsive, accurate. The muzzle adjustment integrated in the sight base makes it easy to adjust the barrels without re-bluing or re-soldering.

OPTIMA THE GENUINE DOUBLE RIFLE DRILLING



Optima 20 "Big Five" caliber .375 H&H Mag.

Optima 20 double rifle drilling with see-through sight, custom engraved with upgraded wood.

Optima 20 double rifle drilling soldered with muzzle adjustment.

"Big Five" double rifle drilling, traditionally soldered.

OPTIMA 20 „BIG FIVE“ DOUBLE RIFLE DRILLING

Steel trigger plate and screw-in cylinder weighted stock bolt for balance/weight optimization; open sight with V-shaped rear sight and pearl front sight, "Big Five" stock.

OPTIMA 20 DOUBLE RIFLE DRILLING

Characteristics of real double rifle drilling: Barrel length: 55 cm (21.5")
Gauge: 20 / 76
Rifle caliber: 7 mm to 9,3 mm

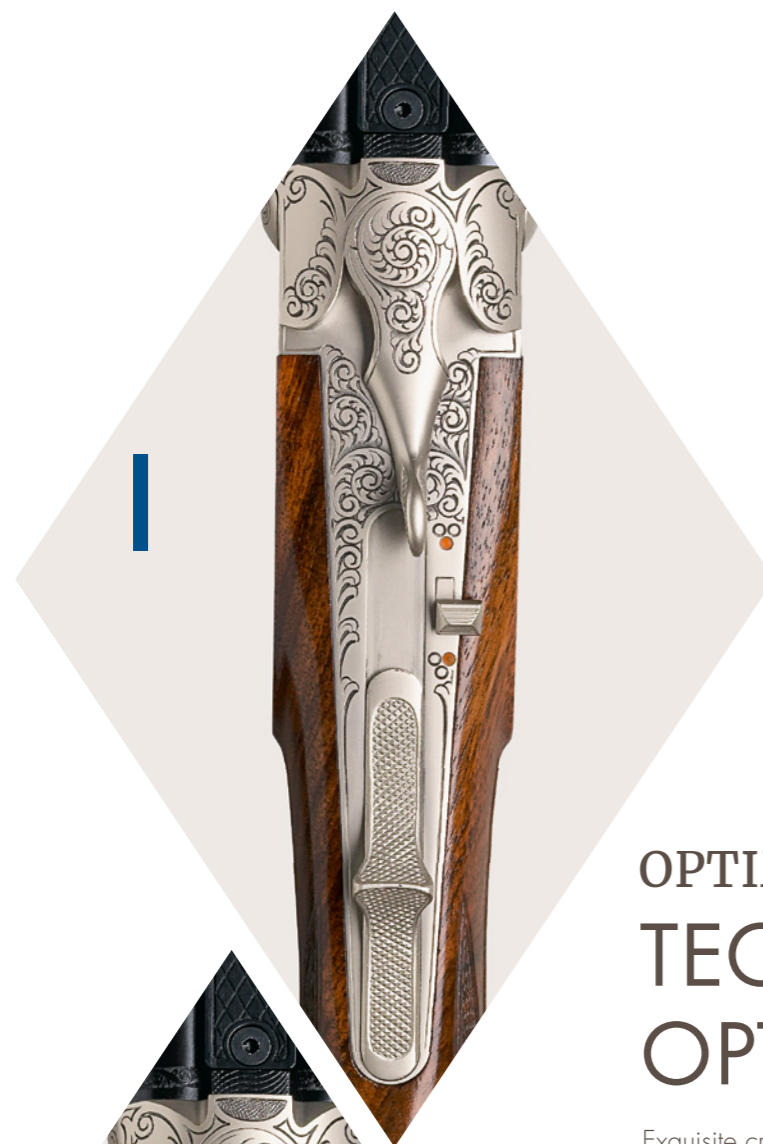

OPTIMA TECHNICAL OPTIONS

Exquisite craftsmanship from the finest gunsmiths for maximum versatility: the combination of side-by-side shotgun and rifle probably make the drilling the greatest all-round hunting gun ever. Krieghoff has more than 135 years of experience and expertise in the manufacture of this noble gun and a long history of successful innovations.

KRIEGHOFF ONE-TWO TRIGGER

Quick and universal. The front trigger is configured as a single trigger that sequentially fires the lower/right barrel, or right/left barrel, depending on the position of the selection lever.

KRIEGHOFF ONE-TWO SPECIAL TRIGGER

The ideal trigger for the double rifle drilling. The front trigger is configured as a single trigger for both rifle barrels and the rear trigger fires the lower barrel. The selector is not required with this trigger system.

COMFORTABLE RESPONSIVE SHOOTING

The front trigger of the Optima is equipped with a set trigger. A set trigger is also available as an option for the rear trigger. For optimal comfort, an automatic set trigger release is available on request. This device disengages the set triggers automatically when uncocking the gun and prevents involuntary setting of the triggers while uncocked.



DRILLING TRIGGER

With the classic trigger of the Optima drilling, the front trigger fires either the lower barrel or the right barrel. The rear trigger operates the left barrel. Additionally, with the Optima drilling the front trigger is equipped with a hair trigger.

1. All Optima drillings are designed for easy installation of a bridge pivot mount.
2. The optional Krieghoff see-through sight in the special fold-down version for the Optima Drilling.
3. By using the three-point radial adjustment, the point of impact of the thermo-stable rifle barrel can be adjusted.

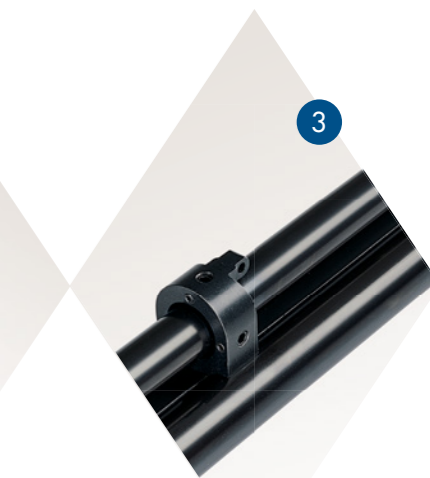

ALL- ROUNDER FOR HUNTING

As a passionate hunter, I combine my love of nature with the pursuit of perfection and trust Krieghoff's Optima for good reason. The quality and craftsmanship that come together here are outstanding. Every aspect is meticulously designed - from the precise trigger action to the guidance that emerges. This ensures that I can focus fully on the hunt.



Jonas Baumgärtner



OPTIMA ENGRAVINGS

Take a look at our selection of catalog engravings and custom engravings. One example of the unlimited possibilities is shown below: exquisitely crafted hunting scenes in deep relief, framed tastefully in gold and finished with fine English style scroll. Intricate wood carvings on the stock completes the picture.



◆◆
catalog engraving
with sideplates:
„Large game scene with
leaf arabesques”



◆◆
catalog engraving:
„standard pattern with
border engraving”



◆◆
catalog engraving:
„French arabesques”

Further examples can
also be found at
[www.krieghoff.de/
engraving](http://www.krieghoff.de/engraving)



HUBERTUS



- Combi-Cocking Device
- Universal Trigger System
- Compact, elegant action
- Optional Dural receiver
- Optional octagonal barrel
- Optional magnum calibers

HUBERTUS SINGLE SHOT RIFLE WITH OCTAGONAL BARREL

Various Caliber and Engraving options are available in addition to the standard offering.

Weight: approximately 2,6–3,3 kg

Figure: Krieghoff Hubertus single-shot rifle with octagonal barrel, pistol grip cap and stock magazine. Especially elegant model with side plates, special engravings with thistle foliage ornamentation and exclusive stock wood.



Ready to accept Bridge Pivot Mount.



walnut wood available in eight progressive grades
Hand-crafted Custom stocks
Ideal for stock magazine

“The perfect barrel for the perfect shot.”



KRIEGHOFF-HUBERTUS
THE JOY OF SIMPLICITY

ranging from 5.6 mm to 9.3 mm can be selected. Standard or magnum caliber available.

Information on octagonal barrels can be found on the following page.

Receiver material: steel or Dural/
Optional side plates/
Very popular for 'Facon Exclusive'

Choose your standard engraving, or have our engravers use your own design.

Inspiration for custom engravings can be found on pages 44–45.



HUBERTUS SINGLE SHOT RIFLE

Standard amenities include: Border engraving, stock with Bavarian cheek piece and recoil pad, Schnabel-style forearm and removable sling swivels.

Weight, standard caliber: approximately 2,5–3,2 kg

Figure: Hubertus single-shot rifle, steel receiver with nitride surface finish, standard engraving „Fine Englishscroll with roses”

HUBERTUS STANDARD FEATURES

- Trigger with hair trigger
- Universal trigger system
- Combi-Cocking device
- Steel trigger guard
- Removable sling swivels
- Ready to accept bridge pivot mount
- Nickel-plated receiver
- Steel trigger plate (with steel receiver)
- Standard border engraving
- Blued hinge pin, locking lever, cocking slide, and trigger guard
- standard wood grade
- Righthanded stock with Bavarian cheekpiece
- Schnabel-style forearm
- Supplied in a Krieghoff GunPack

HUBERTUS TECHNICAL OPTIONS

For us, as hunters and shooters, a single shot rifle is always something very special: its simple beauty and versatility makes it the rifle for those precious moments in our lives that call us to the hunt.



THE OCTAGONAL BARREL

The octagonal barrel gives the Krieghoff Hubertus an elegant, traditional look. This barrel contour is available in selected standard calibers and lengths of 55 cm and 60 cm.

SCOPE

Krieghoff Hubertus express-style rib is silver soldered, providing a reliable and solid base for a scope mount. Even with frequent detach and reattach, the point of impact does not change. The bridge pivot mount also permits several different scopes to be used for the same gun without any problems. Users have a choice of mounting scopes with either rails or rings.

1. Stock Magazine: This additional accessory is one of the most popular extras for single shot rifles, storing spare cartridges close at hand. The stylish cover with matching engraving is a genuine showpiece.



2. Muzzle Thread: Depending upon the design, the Krieghoff Hubertus can also be provided with a muzzle thread for the use of a silencer. When not in use, the thread is hidden and protected by a cover that fits into the contour of the barrel.



AT HOME IN NATURE AND ON THE HUNT

My name is Sabrina Bloch. I come from Switzerland and have hunted all my life. For me, nature is not just a place and hunting is not merely a hobby – it's where I'm at home. When I'm stalking game with my Krieghoff Hubertus, I am especially close to nature. Every shot has to count. Perfection is essential.



Sabrina Bloch



HUBERTUS ENGRAVINGS

Perhaps the appeal of designing every single detail with the utmost care lies within the limitations of the single barrel. With beautiful wood and fine engravings, the Krieghoff Hubertus invites us to turn our dreams into reality and to revel in the joy of the extraordinary.



Figures:
This exclusive piece - the „Gun of the Year 2013“ - is a Krieghoff Hubertus single shot rifle, .270 Win. caliber. The single shot rifle with 'Facon Exclusive,' exclusive stock wood, elegant hand-crafted stock and hand-polished finish, features a masterful engraving on the side plates, with African wildlife and details in yellow and green gold.



◆◆
custom engraving: „Border engraving with inlaid gold lines on the breech end of the barrel, blued“



◆◆
custom engraving: „Border engraving in silver with side plates, blued thistle flower in gold and silver on the top lever“

◆◆
catalog engraving: „Small game scene with leaf arabesques“

◆◆
custom engraving: „Fine English“



Further information on Engravings can be found at www.krieghoff.de/engravings





CLASSIC





Available in barrel lengths of 55 cm (21.5") and 60 cm (23.5").

Barrel configurations can be found on page 53.

CLASSIC „BIG FIVE“ DOUBLE RIFLE

The big game version of the Classic has all the attributes of the legendary Safari rifles.

Rifle calibers: .375 H&H Mag., .450/.400 N.E., .500/.416 N.E. (3 1/4"), .470 N.E., .500 N.E. (3")
Weight: approx. 4,2-4,8 kg

Figure: Caliber: .470 N.E., custom engraving, wood category 1. "Big Five" stock shape, with 15 mm "Old English" recoil stock pad including screw-in cylinder for balance/weight optimization. Double trigger with hinged front trigger shoe.



Receiver material; steel /Optional side plates. Very popular for Facon Exclusive.

Choose from our catalog engravings, or have our engravers use your own design.

Inspiration for custom engravings can be found on pages 56-57.



CLASSIC DOUBLE RIFLE

The most popular version of the Classic. The successful continuation of a history of legendary double rifles.

Weight: approximately 3,3-3,7 kg

Figure: Caliber: 8x75RS, custom engraving, breech-end engraving in gold, wood category 3. Double trigger with hair trigger, optional single trigger



DOUBLE SHOTGUN CLASSIC

The interchangeable double shotgun barrel provides additional ways to carry the Classic. The excellent balance and familiar handling of the gun ensure hunting success.

Shotgun caliber: 20/76, Barrel length: 71 cm (28")
Weight: approx. 2,9-3,1 kg

Figure: catalog engraving: "Small game scene"

CLASSIC THERE'S ONLY ONE CLASSIC

- Combi-Cocking device and Universal trigger system
- Solid breech
- Easily accessible chamber
- Muzzle adjustment – up to caliber 9,3x74R
- Intelligent Ejector System (IES)
- Optional single trigger



Burled walnut wood available in eight progressive grades
Special forms for the stock

CLASSIC STANDARD FEATURES

- Steel receiver
- Universal trigger system
- Combi-Cocking device
- Steel trigger plate (with steel receiver)
- Removable sling swivels
- Nickel-plated receiver
- Ejector (IES)
- Standard border engraving
- Blued hinge pin, locking lever, cocking slide, and trigger guard
- Standard stock wood
- Schnabel-style forearm
- Supplied in a Krieghoff GunPack

“A Dream Becomes Reality.”

CLASSIC TECHNICAL OPTIONS

African adventure: The double rifle is traditionally the first choice in the hunt for the "Big Five", with the instant availability of a second round as life insurance against dangerous wildlife. In principle, it combines two fully independent weapons in one timeless classic.



BIG 5

INTELLIGENT EJECTOR SYSTEM

Sometimes a fraction of a second determines hunting success.

Eject or extract: Krieghoff's "intelligent" ejector system allows an intuitive way out of the situation. If the cocking slide is in the forward position, the ejector throws the spent cartridge out; the gun can be reloaded and is instantly ready to fire. If the cocking slide is pushed to the back, the ejector pulls the spent cartridge out and the gun can be silently reloaded.

The functions can be adjusted without any tools or awkward handling. Simple thumb pressure on the cocking slide is used to control the process: quickly, easily and absolutely safely.



BARREL SETS FOR THE CLASSIC

Krieghoff's "side-by-side" concept offers maximum flexibility. Every barrel configuration - double rifle, shotgun/rifle combination, or double shotgun - can be inserted into any Classic. This is true even for interchangeable barrels in big game calibers. The receiver can be equipped with different types of barrels and used for a wide range of hunting situations.



Large calibers are of course also noted for their greater recoil. The weight of the Classic and Classic "Big Five" guns is always matched to the respective caliber. The recoil reducer noticeably reduces recoil and can also be retrofitted.

The standard sight for the Classic "Big Five" is a wide V-shaped rear sight (with a white, vertical insert) and front pearl sight. A "Super Express" folding sight with standard sight and two folding rear blades is also available as an option. This type of sight is not only a stylistically appropriate detail for a safari rifle, but also has practical advantages when shooting over the notch and bead.



IMPRESSIVE IN EVERY ASPECT

It is the Krieghoff combination of craftsmanship and innovative technology that has always fascinated me. The consistently precise shooting, the reliability, and the safety of the gun prove to me on a daily basis that I have one of the best.

Henrik Lott

CLASSIC ENGRAVINGS

The engravings for the Classic are tastefully tailored to the slim receiver of this fine rifle and paired with corresponding high-quality walnut wood in the stock.



◆◆
 custom engraving:
 "Animal scenes crafted in the
 bulino style, partly inlaid
 in gold. Framed by fine
 foliage ornamentation."

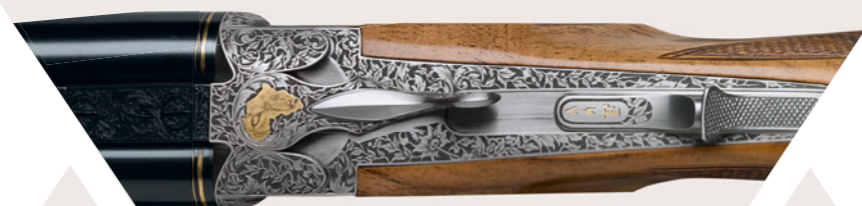

◆◆
 catalog engraving:
 "Big Game"



◆◆
 catalog engraving:
 "Safari Scroll 1"



Further information on
 Engravings can be found at
www.krieghoff.de/engravings



Figure:
 Custom engraving with a variation of
 powerfully carved leaf arabesques and fine
 English arabesques, combined with a
 realistic scene from the red deer rutting
 season lend this Classic a very
 special flair.





ULTRA 20





- Full flexibility from the twin hammer Combi-Cocking device
- Optional steel shot proofing
- Choice of Thermo Stable (TS) barrel set or soldered barrel set
- Insert barrels in big game calibers possible
- Single trigger for over-and-under double rifle

ULTRA 20 PASSION AND PERFECTION

A large selection of insert barrels is available.



Caliber: 6,5x57R, 6,5x65R, 7x57R, 7x65R, .308 Win., .30-06, .30R Blaser, 8x57IRS, 8x75RS, 9,3x74R

Barrel lengths of 55 cm [21.5"] or 60 cm [23.5"] available
Barrel configurations can be found on pages 64-65.



Ready to accept bridge pivot mount.



Receiver material; steel or Dural / Optional side plates. Very popular for "Facon Exclusive"

Choose from our catalog engravings or have our engravers use your own design.

Inspiration for custom engravings can be found on pages 68-69.



Walnut wood available in eight progressive grades
Custom dimension for the stock

ULTRA STANDARD FEATURES

- Hair trigger in front trigger
- Universal trigger system
- Combi-Cocking device
- Steel trigger guard
- Ready to accept bridge pivot mount
- Suitable for loading steel shot depending on choke and receiver material
- Removable sling swivels
- Steel trigger plate (with steel receiver)
- Nickel-plated receiver
- Engraving with border
- Blued hinge pin, top lever, cocking slide, and trigger guard
- Standard stock wood
- Right-handed stock with „Bavarian Cheekpiece“
- Schnabel-style forearm
- Supplied in a Krieghoff GunPack

ULTRA 20 OVER-AND-UNDER DOUBLE RIFLE

The classic configuration for woodland deer, driven hunts, or the stalk abroad.

Weight: approx. 3,2-3,9 kg

Figure: Ultra 20 "TS" over-and-under double rifle, barrel length 55 cm [21.5"], cosmetic side rib, see-through sight, catalog engraving „Large game scene with oak leaves“.

ULTRA 20 TWO CALIBER RIFLE/RIFLE COMBINATION

The "mixed double" with small and large caliber for passionate rifle specialists.

Weight: approx. 3,1-3,8 kg

Figure: Ultra 20 "TS" two caliber rifle/rifle combination, barrel length 55 cm, cosmetic side rib, custom engraving, side plates



ULTRA 20 OVER-AND-UNDER COMBINATION RIFLE/SHOTGUN

Figure: Ultra 20 "TS" over-and-under combination rifle/shotgun, barrel length 55 cm [21.5"] cosmetic side rib, "Standard" engraving, blued receiver

The most frequently used combination for everyday hunting. The Ultra 20 demonstrates just how much flexibility and adaptability can be expected from a modern over-and-under gun. The over-and-under combination rifle/shotgun is the basic gun for expansion using the Krieghoff "KS" insert barrel, making it a two-caliber rifle/rifle combination or an over-and-under double rifle. Krieghoff's twin hammer action with Krieghoff Combi-Cocking device is the key to maximizing the versatility of the Ultra 20, because only a quick second shot enables the double rifle to be fully effective. A wide range of technical options enables the creation of a slim and responsive beauty made of steel and selected wood.

Weight: approx. 2,7-3,4 kg

“The all-round gun that hunters always take without a second thought.”



ULTRA 20 TECHNICAL OPTIONS

The standard Ultra 20 comes with border engraving, recoil pad, right-handed stock with "Bavarian cheekpiece", Schnabel-style forearm, and removable sling swivels. The Ultra 20 can be modified to perfectly suit personal preference by choosing from a long list of additions and options.



Another design strength of Krieghoff "KS" insert barrels is the separate, full performance extractor, which simply replaces the standard extractor. This makes handling easy, quick and safe.

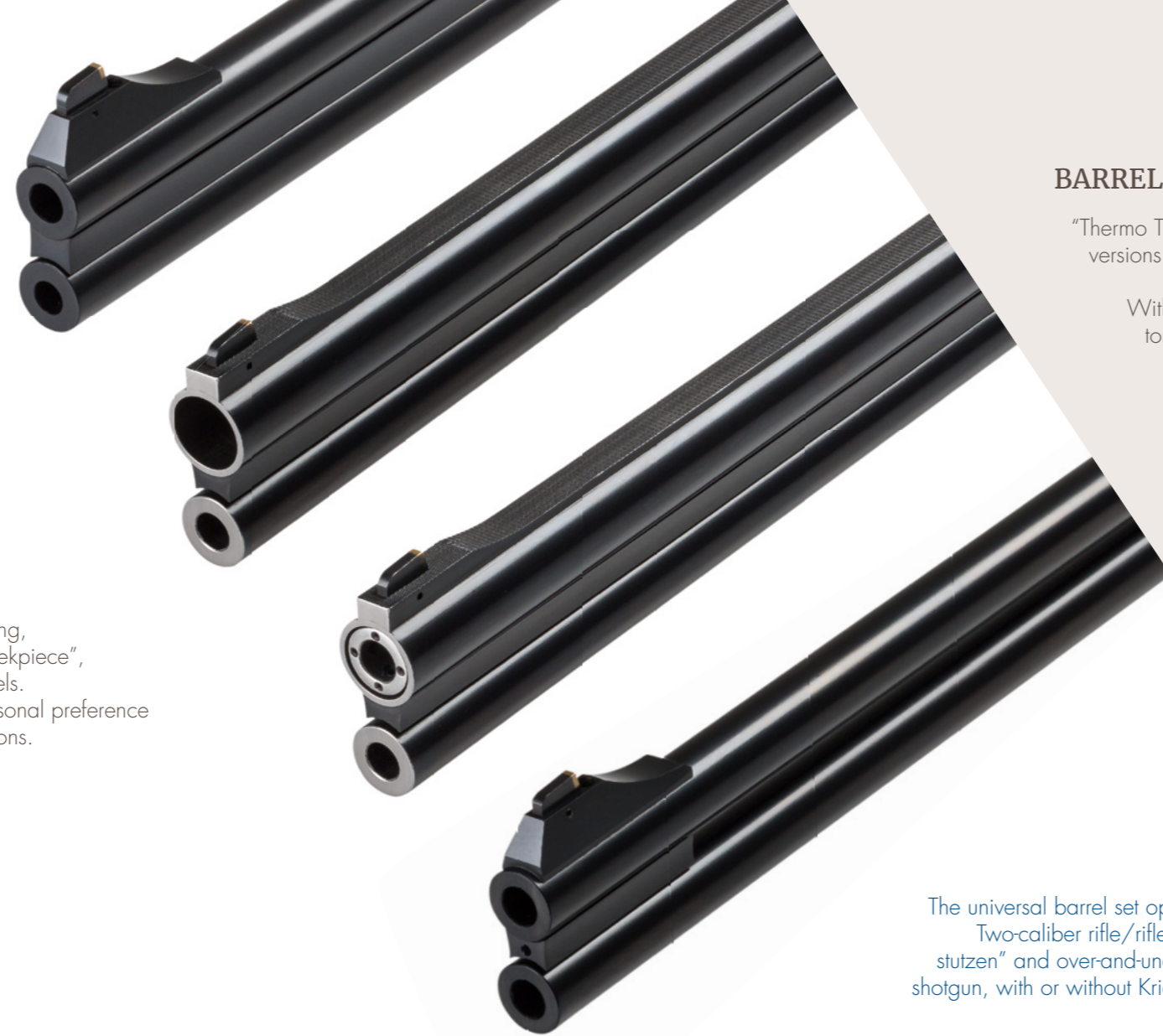

BARREL SETS FOR THE ULTRA 20

"Thermo TS Stable" barrel sets are available for all versions of the Ultra 20.

With the thermally stable Ultra 20 "TS" barrel set, torque caused by barrel heat up is no longer an issue. No climbing occurs and the point of impact remains constant even after several shots.

Another advantage over soldered barrels is the ease of regulating the barrels when changing ammunition or if the point of impact of the rifle barrel has to be adjusted to the point of impact of a slug from the shotgun barrel.

Pictured:
The universal barrel set options for the Ultra:
Two-caliber rifle/rifle combination "Bergstutzen" and over-and-under combination rifle/shotgun, with or without Krieghoff "KS" insert barrel



The steel cosmetic side rib gives Thermo "TS" Stable barrel sets a traditional appearance.



Regulating the barrels is easily accomplished by using the three-point radial adjustment for the "TS" barrel set.



A GENUINE, UNCOM- PROMISING ALL-ROUNDER

My name is Rebecka Bergkvist and hunting is my passion. After I became the world champion and world runner up in sporting clays in 2016 and 2017 using my competition shotgun, the Krieghoff K-80, I decided it was time to stop compromising in hunting. In Sweden, where I am from, there is a long tradition of rabbit, fox and deer hunting. My Krieghoff Ultra combination rifle/shotgun is absolutely brilliant in this regard, and with the .30-06 caliber it is simply superb. I can hunt anything from rabbits to elk with one gun. My faithful Münsterländer "Selfie" and my Ultra are genuine all-rounders and accompany me on every hunt.



Rebecka Bergkvist



ULTRA 20 ENGRAVINGS

The entire spectrum of Krieghoff options is also available for the Ultra 20. The examples shown here underline the harmonious overall statement made by the engravings and the matching high-quality grade of wood used for the stock.



Figure:
The photos show a fine Ultra 20 "TS" over and under combination rifle/shotgun with side plates, Facon Exclusive contouring and nitride receiver finish. The game scene engraving in relief is framed by English arabesques. Gold inlays grace the breech end of the barrel. The handcrafted stock with fine checkering is framed in English arabesques. The elaborate artwork extends to small features such as the pistol grip cap, cocking slide and forearm catch.



◆◆
catalog engraving:
"Small game scene
with oak leaves"



◆◆
catalog engraving:
"Hand-engraved
arabesque motif on
both sides"



◆◆
catalog engraving:
"Large game scene
with oak leaves"



◆◆
Figures
Luxurious, full coverage ornamentation with deep relief oak leaves. The top tang and underside of the receiver, trigger guard and top lever are also elaborately engraved.



Further information on Engravings can be found at www.krieghoff.de/engravings

VICTORIA FOR LADIES ONLY



VICTORIA

Named specifically after the Goddess of Victory, the Victoria line stocks are built with a purpose. The shorter length of pull, appropriate pitch and cast, and tailored palm swell that fits the elegance of the female hand leads to a smooth instinctive aim and precise shooting for all situations. Light, graceful, and carefully designed for the female shooter, the Victoria features a balanced receiver and light barrels.

K-80 Victoria



K-20 Victoria



THE K-20 VICTORIA STANDARD EQUIPMENT

- 20 and 28 gauge
- Barrels: Parcours 30" or 32" (76 cm or 81 cm)
- Rib: 7 – 6 mm taper flat
- Fixed chokes M and IM, optional KTW chokes
- Standard grade engraving
- Ladies Victoria stock with adjustable comb
- Oil finish with special Victoria checkering
- Weight: Appx 7 lbs (ca. 3100 g)

*shown with upgraded wood and Eleganza engraving

THE K-80 VICTORIA STANDARD EQUIPMENT

- 12, 20 and 28 gauge
- Barrels: Parcours 30" or 32" (76 cm or 81 cm)
- Rib: 7 – 6 mm taper flat
- Fixed chokes M and IM, optional KTW chokes
- Standard grade engraving

- Ladies Victoria stock with adjustable comb
- Oil finish with special Victoria checkering
- Weight: Appx 7 lbs (ca. 3180 g)

*shown with upgraded wood and Vienna engraving





ESSENCIA IN A CLASS OF ITS OWN

Pure elegance, first-class craftsmanship and proven technology: the Essencia is a side-by-side shotgun which falls into the same category as the highly coveted "best" English or Italian guns.

ESSENCIA SIDE-BY-SIDE SHOTGUN STANDARD CONFIGURATION:

- Round-bodied steel receiver
- Sidelocks
- Purdey-style third bite
- Double barrel-hook lock-up
- Ejectors
- Fine English scroll engraving with gold
- Color case-hardened finish
- Choice of straight-grip or Prince-of-Wales pistol grip stock
- Wood category 003
- Traditional Tru-Oil finish
- Supplied in an exclusive leather hard case



TRUMPF A REAL CLASSIC

TRUMPF STANDARD FEATURES

- Genuine three-lock drilling
- Self-cocking firearm with separate rifle cocking mechanism
- Hair trigger in front trigger
- Universal Trigger system
- Steel trigger guard
- Removable sling swivels
- Ready to accept pivot bridge mount
- Suitable for loading steel shot depending on choke and receiver material
- Steel trigger plate (with steel receiver)
- Nickel plated receiver
- Standard border engraving
- Blued hinge pin, top lever, cocking slide, and trigger guard
- Standard stock wood
- Right-handed stock with „Bavarian cheekpiece“
- Schnabel-style forearm
- Supplied in a Krieghoff GunPack



Rifle caliber: 6,5x57R, 6,5x65R, 7x57R, 7x65R, .308 Win., .30-06, .30R Blaser, 8x57IRS, 8x75RS, 9,3x74R



Available in barrel lengths of 55 cm (21.5") or 60 cm. (23.5")



Burled walnut wood available in eight progressive grades
Hand-crafted stock options

TRUMPF DOUBLE RIFLE DRILLING

20 gauge shotgun barrel,
Engraving „Small game scene with oak leaves“
Weight: 3.9 kg



A large selection of insert barrels is available.

TRUMPF DRILLING

TrumPF drilling, 12 gauge, soldered barrel sets, standard engraving „Small Arabesques“.
Weight: approx. 3,1-3,7 kg



Receiver material; steel or Dural /Optional side plates. Very popular for Facon Exclusive.

Choose from our catalog engravings, or have our engravers use your own design.

Inspiration for custom engravings can be found on pages 70-71.

TRUMPF TECHNICAL OPTIONS AND ENGRAVINGS

Our completely handcrafted guns testify to a mastery of the classic art of gunmaking that is rarely encountered today. The entire repertoire of this ancient craft is on display here: from the border decoration on the barrels to the flawless stock and the meticulous engravings. The guns created in this manner make the hearts of connoisseurs beat faster and reflect a knowledge of the history of hunting weapons that is seldom found today. The art of gunmaking as a link between the most sophisticated technology and the finest esthetics defines the philosophy behind this gun.

Trumpf drilling,
shot caliber 20 gauge



The steel receiver of the
three-lock drilling is made
from high-strength
chrome molybdenum steel.



◆◆
Hand-engraved arabesque
motif on both sides.



◆◆
Figure:
Finely detailed game scene
and deeply engraved oak leaf
ornamentation on each side.
Choice of animal motifs.
The oak-leaf ornamentation
continues all around the top and
underside of the receiver.



Further information on
Engravings can be found at
www.krieghoff.de/engravings



Figure:
Trumpf Drilling with side plates, "Large game
scene with oak leaves" engraving,
special stock, "Exclusive Facon"

SERVICE TECHNOLOGY WITH SYSTEM

Anyone who understands the practical aspects of hunting knows what to expect from the technical features of a hunting gun. Any hunting scenario demands full concentration. Being ready to fire immediately and maintaining utmost safety are mere fractions of a second apart. The gun's handling must therefore be straightforward and intuitive – never distracting or difficult.

KRIEGHOFF UNIVERSAL- TRIGGER SYSTEM

(Optima, Ultra, Classic, Hubertus and Trumpf)

◆◆ Firing quickly and intuitively to hit the target: hunting situations demand rapid, reliable responses. Only an optimized trigger enables you to make the most of every opportunity. A trigger pull weight being too heavy compromises accuracy. If the trigger pull weight is too low, inadvertent firing is a risk, due to icy fingers that have lost their feeling during a driven hunt in winter, for example. Krieghoff's Universal Trigger System is set to release cleanly and precisely at 1200 -1500 grams, without the risk of doubling. Precisely hitting the target over long distances demands a stable rest, a steady pulse and a trigger that releases precisely and with minimum resistance. That's why the Krieghoff Universal Trigger System includes a hair trigger.

Krieghoff's hair trigger feature is optional for the rear trigger on guns with double triggers. The optional automatic hair trigger release makes safe handling even easier. To uncock the gun, move the cocking slide to the rear position and it automatically releases the hair trigger.

KRIEGHOFF COMBI- COCKING DEVICE

(Optima, Ultra, Classic, Hubertus as well as bottom barrel of Trumpf)

◆◆ An uncocked gun is a safe gun. Every Krieghoff has a Combi-Cocking Device and can be carried safely with its hammers uncocked. Just before a shot is fired, the ergonomically designed cocking slide is pushed forward with a smooth, practically noiseless motion. The gun is now cocked and ready to shoot. If the shot is not fired, you can uncock the gun again simply by pushing the cocking device all the way forward and letting it slide back. If the cocking slide is left in the forward position, the gun is automatically re-cocked upon opening, the same as on a self-cocking firearm. After the gun is reloaded and closed, it is ready to be fired immediately. Krieghoff's Combi Cocking Device offers important advantages without compromising safety when fast shooting is required, as when hunting driven European big game.

PERFECT VERSATILITY

The optimal trigger functions reliably and safely in every situation. Its easy handling enables precise shooting. The high-quality trigger system is distinguished by the perfect combination of a crisp trigger and a hair trigger.





SERVICE RELIABLE AT YOUR SIDE

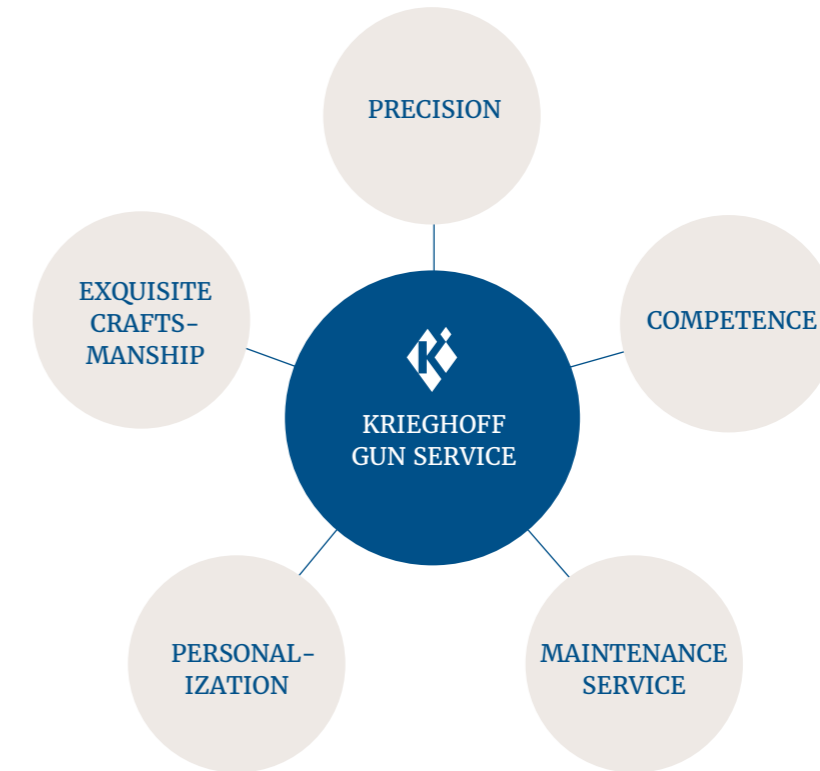

◆◆ Regular maintenance of your quality products from Krieghoff ensures that you can rely 100% on the reliability and safety of your gun even after many years of use. You will find detailed information on our website at: www.krieghoff.de/en/service/gun-service/



Once a Krieghoff, always a Krieghoff. Even after decades we are still with you all the way. We can even service, repair and preserve models we no longer make. The purchase of a Krieghoff offers continuity, reliability and durability.

SERVICE

ABSOLUTELY UNIQUE

Exclusive finishing showcases the gunsmith's fine craftsmanship to perfection and brings the weapon to life. Ties, folds, and tips that are carved, honed, or hammered by master craftsmen dignify a special hunting weapon and create a timeless treasure that will be passed from generation to generation.



ENGRAVING AND FINISHING

◆◆ There are numerous possibilities for finishing your Krieghoff. Optional side plates and pistol grip caps can be engraved according to your wishes just like barrels, stocks, trigger guards, and cocking slides. In addition, the stock wood, the barrels, and all exterior metal parts can be treated with various surface finishes.

KRIEGHOFF GUN SERVICE

With the Krieghoff Gun Service, we offer you a quick and easy way to have your weapon carefully inspected, cleaned and preserved in our factory.



HAND-CRAFTED AND CUSTOMIZED STOCKS

◆◆ A handcrafted stock is defined as a stock that has been manually produced to the largest extent (with only partial mechanical preprocessing), including the comb and/or forearm, from the original blank. Special wishes concerning the stock design (special stock shape, deviations from the standard length, etc.) generally require manual processing of the standard stock shape or a customized stock. In such cases, a personal fitting is essential. Our experienced stock makers ensure that your stock fits you perfectly, enabling you to confirm the truth in Ludwig Krieghoff's old saying: "You shoot with the barrels you hit with the stock" („Die Läufe schießen – der Schaft trifft“).



SCOPE MOUNTS AND SIGHTING-IN

◆◆ Our service offering includes mounting scopes and sighting-in-two elements that are of key importance to the shooting performance of a hunting gun. Stock, barrel, mount, ammunition: all of these components not only directly influence shooting performance, but they also interact with one another.

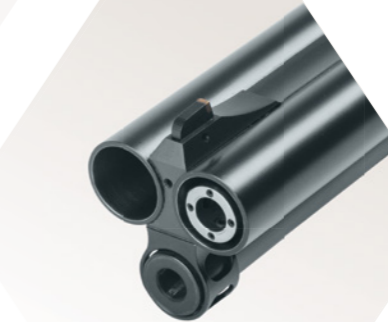

INTERCHANGEABLE AND INSERT BARRELS

◆◆ Our factory can reliably and accurately make technical changes to your Krieghoff, assemble interchangeable barrels, or fit insert barrels. Currently, steel shot proofing for shotguns is of particular interest. If desired, we can install interchangeable chokes can be installed as well. Naturally, all government proofing will be arranged, when required.

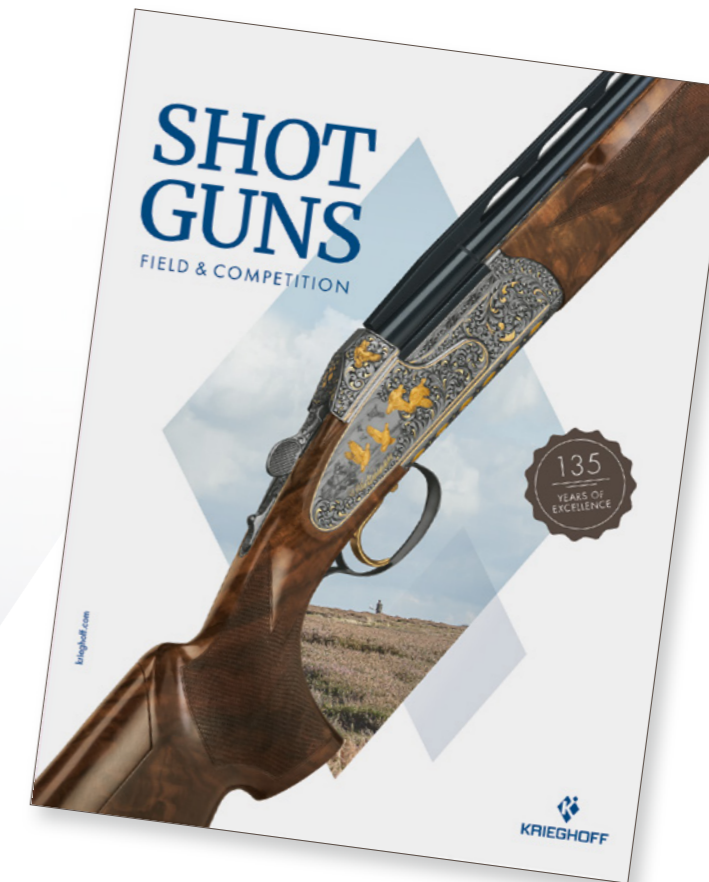

The catalog is available from your specialist dealer
or can be downloaded from the company's website at:
www.krieghoff.de

AVAILABLE NOW NEW CATALOG SHOTGUNS

-  K-80
-  K-20
-  KX-6



H. KRIEGHOFF GMBH

Hunting and Sporting Arms
Boschstraße 22
89079 Ulm
Germany
Fon: +49 731 40182-0
Fax: +49 731 40182-800
info@krieghoff.de

The catalog shows only part of the total range of merchandise.
Our dealer list and complete program can be found at www.krieghoff.de.

Krieghoff, Optima, Essencia, „Die Läufe schießen – der Schaft trifft“®
("You shoot with the barrels you hit with the stock"®) are registered trademarks
with effect in Germany or with effect in selected countries outside Germany.

PUBLICATION DETAILS

We thank everyone who has helped to create this catalog. The firearm images in this catalog are provided to assist you with choosing the best Krieghoff product for your needs. Images shown may differ from actual products due to but not limited to, illustrating upgrades that can be ordered for an additional cost, standard configurations specific to a certain country(ies) but not others, and Krieghoff's decision to use a particular firearm image as a sample of their product.

Krieghoff will not be held responsible for any variation between the products shown in the catalog and the delivered product. Please contact an Authorized Krieghoff Dealer for specific details on any Krieghoff Product you want to purchase. Guns may be purchased only by those in possession of a valid firearm permit.

Photography: Michael Agel, Terry Allen, Thomas Kärcher, Linus Kilpelä Lindstrand, Erich Marek, Etienne Oosthuizen, Horst Rohleder, Klaus Schneider, Sebastian Steinbrink-Minami, Mario Theus, Philipp Zeffass, Stockimages: www.istockphoto.com. All rights reserved.

Version: 08/2023



kriehoff.de